

# GT-P3100\_REV0.6

2012.02.14

sheet01 : 2.5G RF, TRANSCEIVER, 3G RF

sheet02 : GPS, BT/WIFI

sheet03 : PMB9811 CP, DDR SDRAM, SIM

sheet04 : AUDIO part

sheet05 : IF CON

sheet06 : OMAP4430 AP, MOVINAND

sheet07 : AP PMIC, CHARGER, BAT CON

sheet08 : LCD Part, IRDA & KEY

sheet09 : 3M CAM & TSP

|                      |  |
|----------------------|--|
| Project              |  |
| Sheet No.            |  |
| Sheet Title          |  |
| Author               |  |
| Check/Approved       |  |
| GT-P6200_MAIN_REV0.9 |  |
| Sheet No.            |  |
| Sheet Title          |  |
| Author               |  |
| Check/Approved       |  |

# RF\_PART

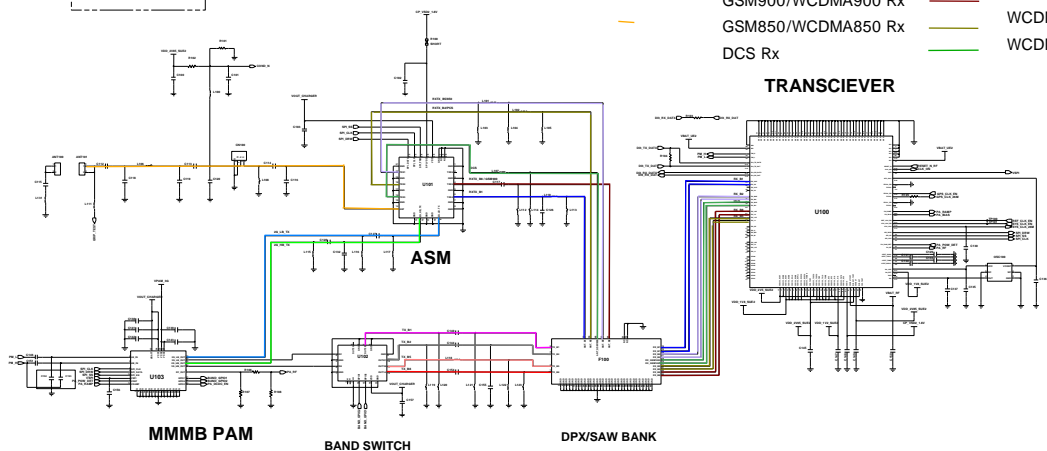

- Legend for signal lines:
- Ant
  - GSM900/WCDMA900 Rx
  - GSM850/WCDMA850 Rx
  - DCS Rx
  - WCDMA2100 Rx
  - WCDMA2100 Tx
  - WCDMA1900 Tx
  - WCDMA900 Tx
  - WCDMA850 Tx
  - GSM\_LB\_Tx
  - GSM\_HB\_Tx
  - WCDMA1900RX/PCS

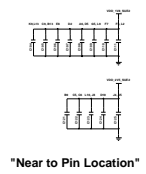

# GRIP SENSOR

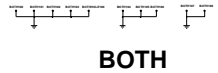
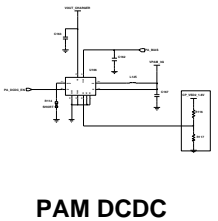
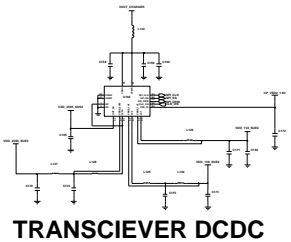
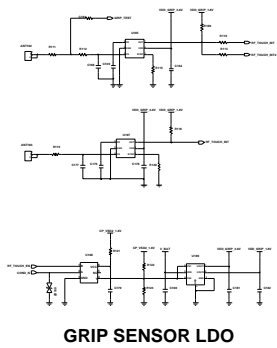

WARNING: CONFIDENTIAL  
ALL INFORMATION CONTAINED HEREIN IS UNCLASSIFIED EXCEPT WHERE SHOWN OTHERWISE

# CONNECTIVITY\_PART

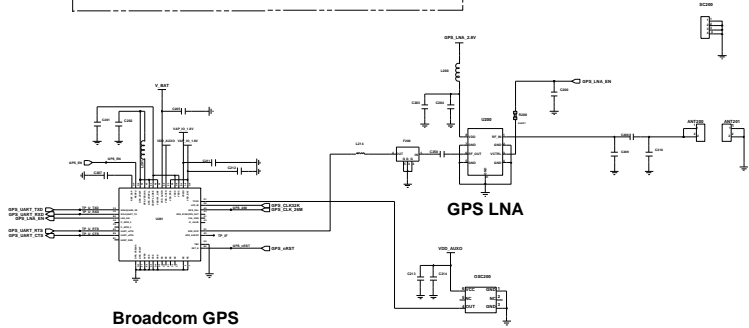

Broadcom GPS

GPS LNA

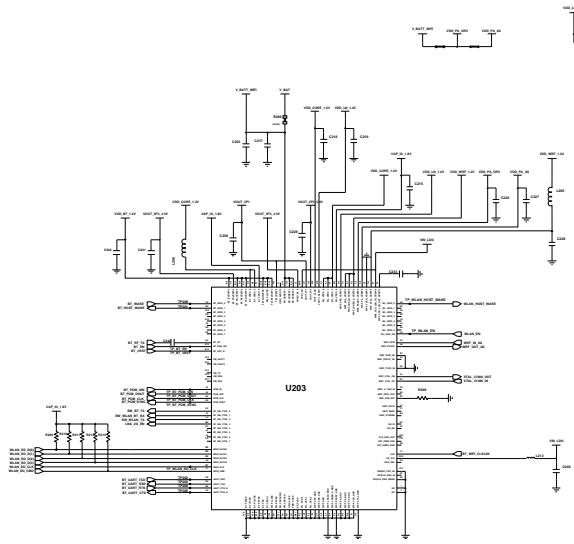
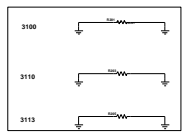

U203

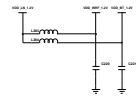

BT/WIFI OSC

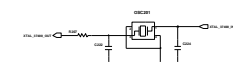

WIFI LNA(2G)

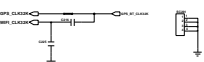





# IF\_PART

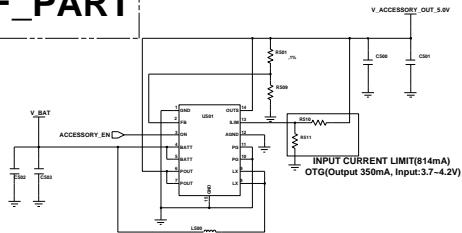

**ACCESSORY\_PWR**

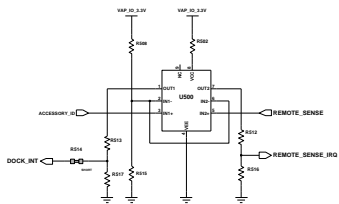

**ACCESSORY\_INT**

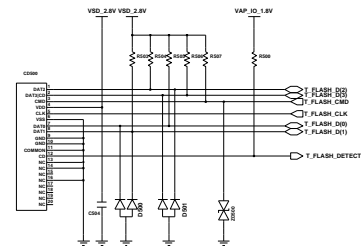

**T-FLASH\_CONN**

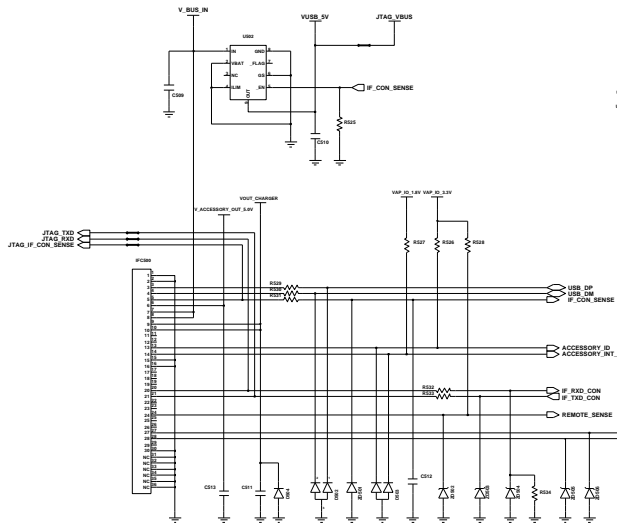

**30pin I/F CONNECTOR**

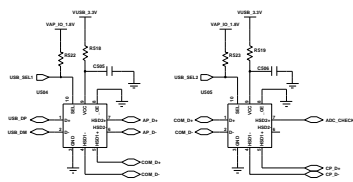

**USB SWITCH IC**

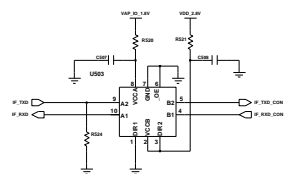

**UART Level Shifter**

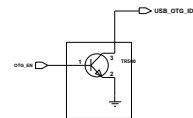

**OTG Enable**

| Project              |      | INTERFACE      |     |
|----------------------|------|----------------|-----|
| Created by PATA      | 1/14 | Rev            | 1.0 |
| FILE CODE            |      | DATE           |     |
| OPERATOR CODE        |      | TESTING PERSON |     |
| WIP DESIGN CODE      |      | TESTING PERSON |     |
| GT-P7500_MAIN_REV0.2 |      |                |     |



UNCLASSIFIED  
 EXCEPT WHERE SHOWN  
 OTHERWISE, THIS DOCUMENT IS UNCLASSIFIED  
 DATE 08-14-2011 BY 60322 UCBAW/SJS

# POWER\_PART

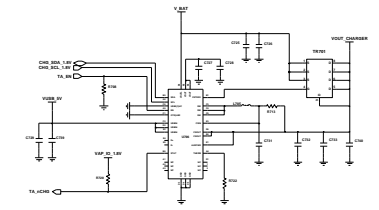
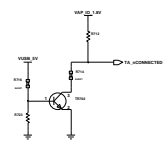
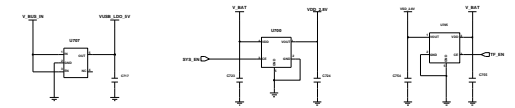
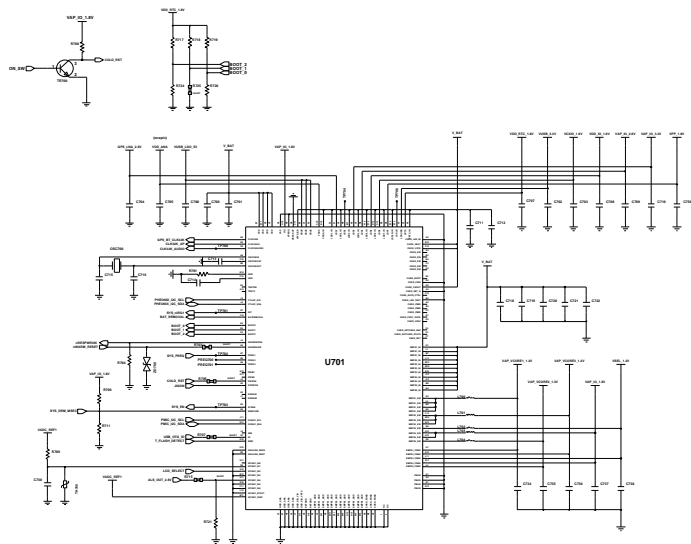

SWITCHING CHARGING BLOCK

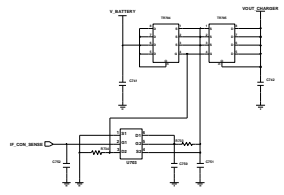

EXT\_JIG\_POWER\_CONTROL

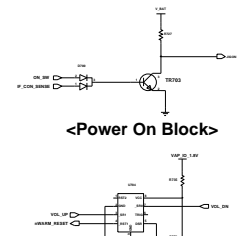

<Power On Block>

RESET IC

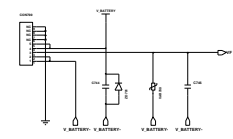

BATTERY CONTACT

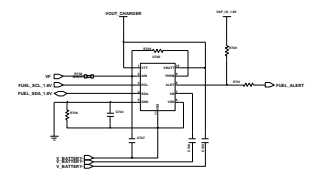

FUEL GAUGE

| POWER PART  |                     |
|-------------|---------------------|
| Part Number | GT-PT500_MAIN_REV02 |
| Revision    | 02                  |
| Author      |                     |
| Checked     |                     |
| Approved    |                     |



**SAMSUNG CONFIDENTIAL**  
 THIS DOCUMENT CONTAINS CONFIDENTIAL  
 PROPRIETARY INFORMATION OWNED BY  
 SAMSUNG ELECTRONICS CO., LTD.  
 IT IS UNLAWFUL TO DISSEMINATE, REPRODUCE,  
 OR TO ATTEMPT TO DISSEMINATE OR REPRODUCE  
 WITHOUT THE WRITTEN AUTHORIZATION OF SAMSUNG.

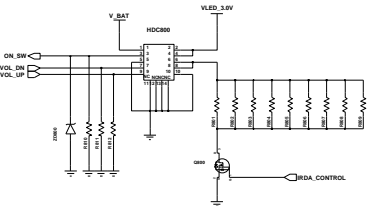

**POWER & VOLUME KEY**

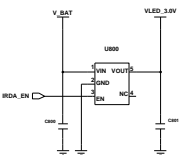

**IRDA LDO(option)**

**LCD\_PART**

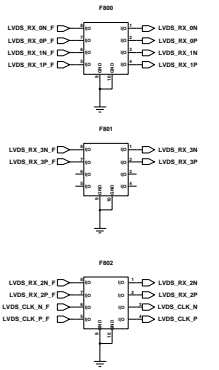
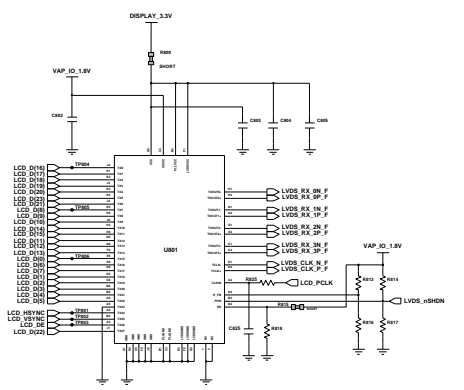

**LVDS Transmitter**

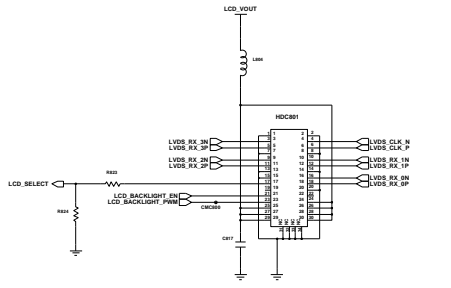
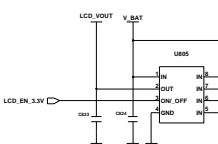
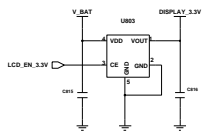

**TSP PART**

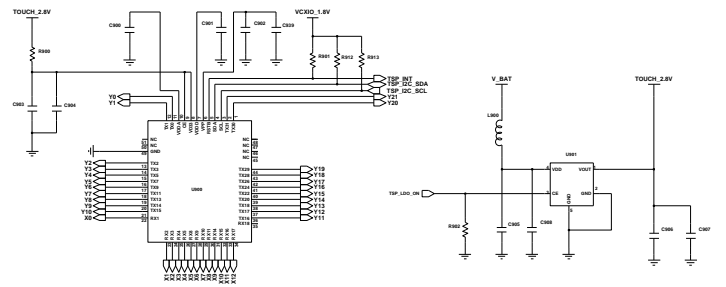

**TOUCH SENSOR IC**

**TOUCH LDO**

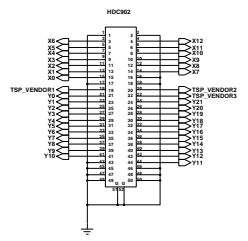

**50Pin TOUCH Con.**

**CAM PART**

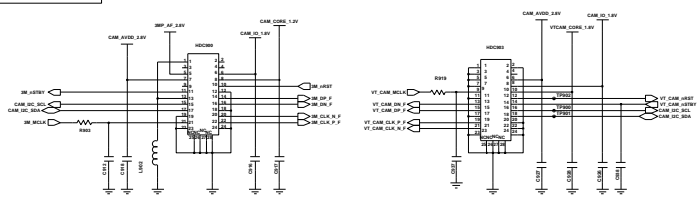

**3M CAM**

**VT CAM**

**SENSOR\_PART**

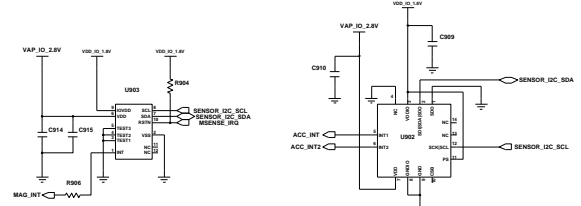

**Magnetic Sensor**

**Accelerometer Sensor**

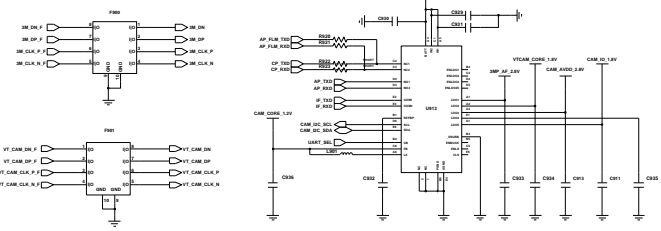

**RCV & Proximity**

|                  |                      |
|------------------|----------------------|
| Project Name     | TSP_SENSOR           |
| Sheet No.        | 1/1                  |
| Rev. No.         | 1.0                  |
| Rev. Description | GT-P7500_MAIN_REV0.2 |
| Rev. Date        |                      |
| Rev. By          |                      |
| Rev. Check       |                      |
| Rev. Approved    |                      |
| Rev. Date        |                      |